

EN DOOR KIT INSTALLATION MANUAL

DE MONTAGEEINLEITUNG TÜREN SET

RU ИНСТРУКЦИЯ ПО УСТАНОВКЕ ДВЕРЕЙ КВАДРОЦИКЛА



For: Polaris Ranger 570 (2015-)

2444.7450.1
444.7450.1



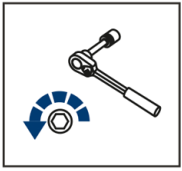

EN Regular fasteners
DE Originale montageteile
RU Штатный крепеж

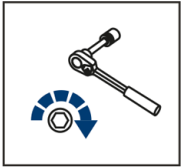

EN Regular fasteners
DE Originale montageteile
RU Штатный крепеж



EN Screw a several turns
DE Für wenigen Umdrehungen befestigen
RU Вкрутить на несколько оборотов



EN Loosen bolts
DE Bolzen lockern
RU Выкрутить на несколько оборотов

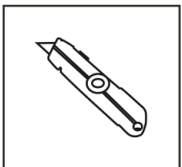

EN Office Knife
DE Büromesser
RU Канцелярский нож

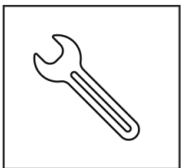

EN Wrench
DE Schraubenschlüssel
RU Гаечный ключ

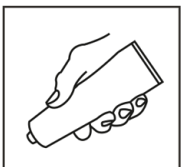

EN Grease
DE Schmierfett
RU Консистентная смазка

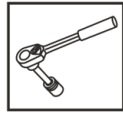

EN Ratchet
DE Ratsche
RU Трещётка

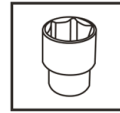



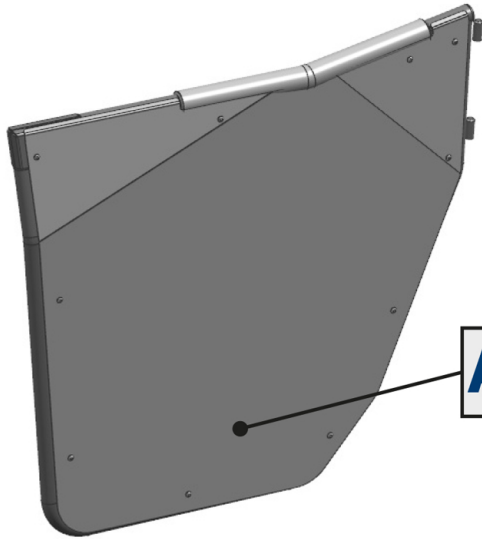

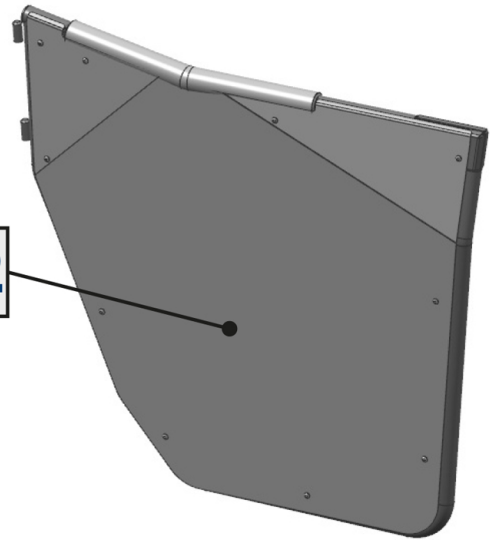

S - 10;
S - 13

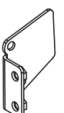
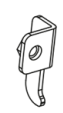

A1

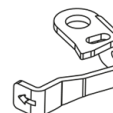
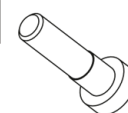
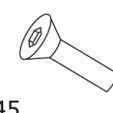
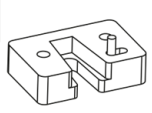
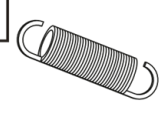
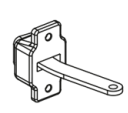
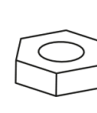
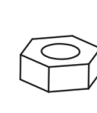
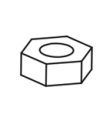
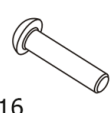
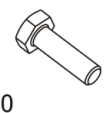
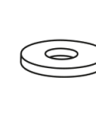
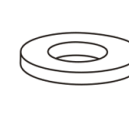
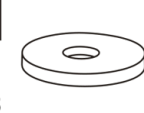
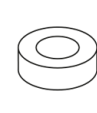

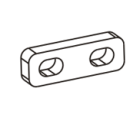
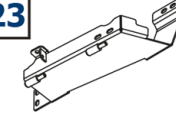
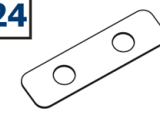
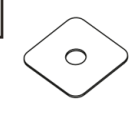
A2

1	 x2	2	 x2	3	 x2	4	 x2	5	 x2	6	 M8x45 x4
7	 x2	8	 x2	9	 x2	10	 M10 x4	11	 M8 x8	12	 M6 x2
13	 M6x16 x4	14	 M8x20 x10	16	 Ø6 x8	17	 Ø8 x10	18	 Ø8 x10	19	 x2
20	 M6x20 x2	21	 x2	22	 x2	23	 x2	24	 x4	25	 x2
26	 x4										

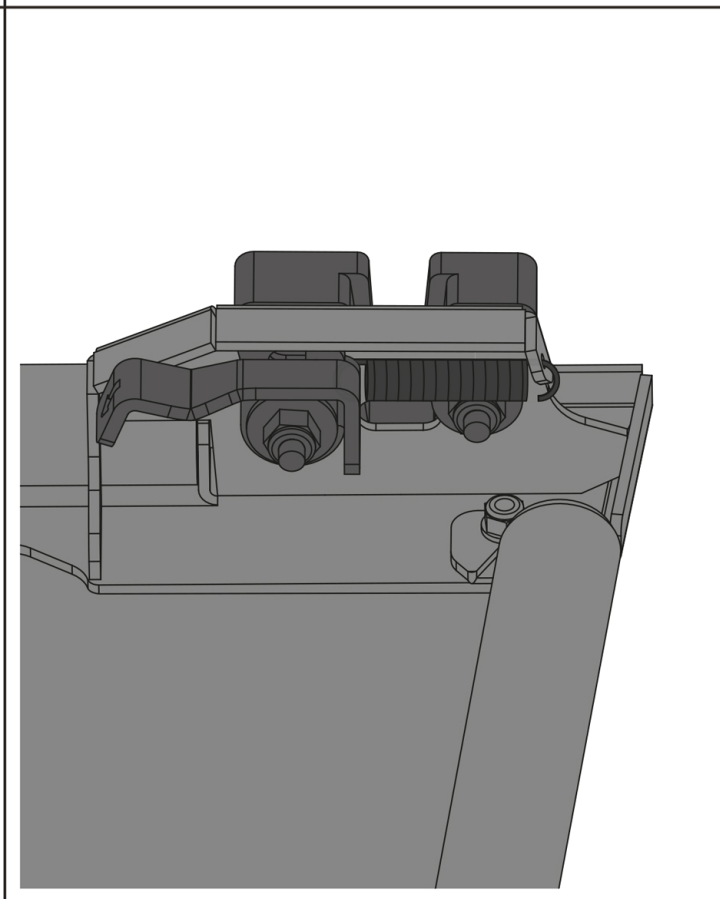
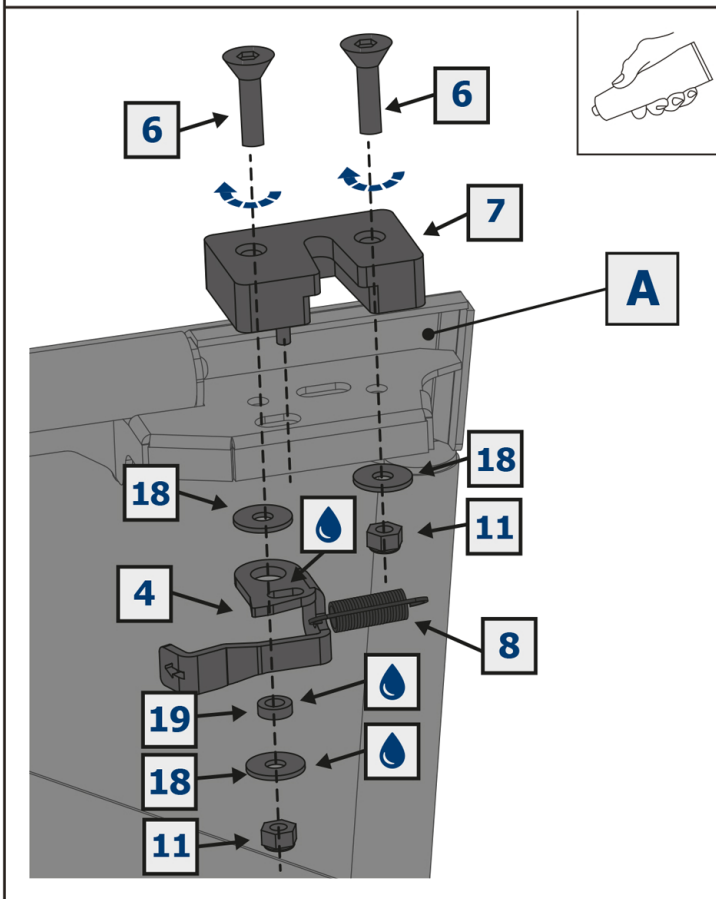
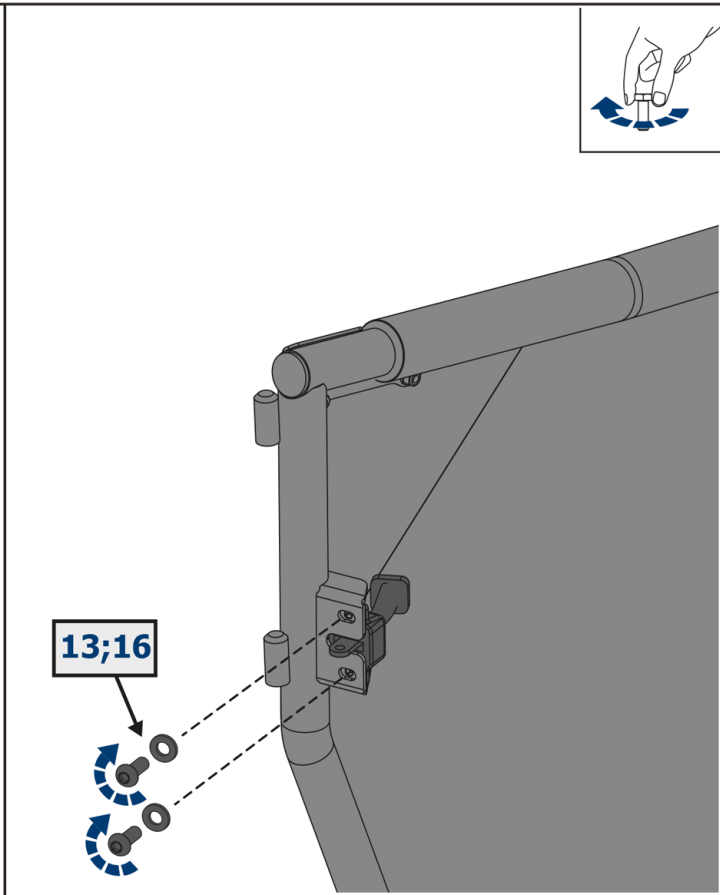
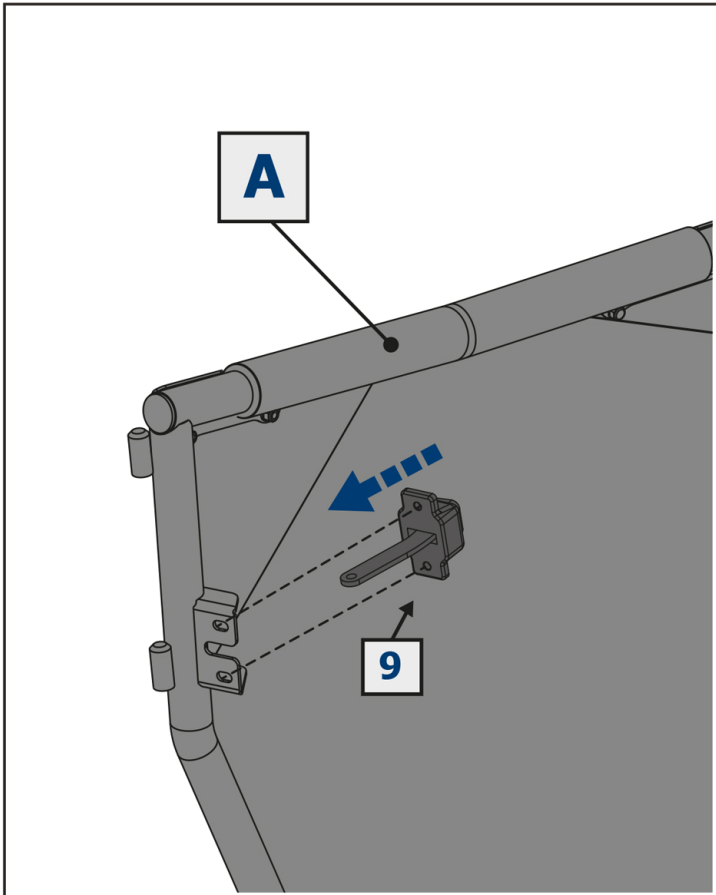





S17

