

EN	SKID PLATE INSTALLATION MANUAL
FR	MANUEL D'INSTALLATION DE PLAQUE DE PROTECTION
DE	MONTAGEEINLEITUNG FÜR UNTERBODENSCHUTZSYSTEM
RU	ИНСТРУКЦИЯ ПО УСТАНОВКЕ КОМПЛЕКТА ЗАЩИТ

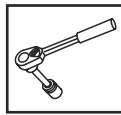

For: Polaris Ranger XP 900 (2011-)
Polaris Ranger XP 1000 (2016-)
2444.7430.1
444.7430.1





EN Ratchet
FR Clé À Cliquet
DE Ratsche
RU Трещетка

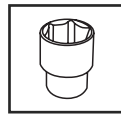



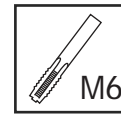

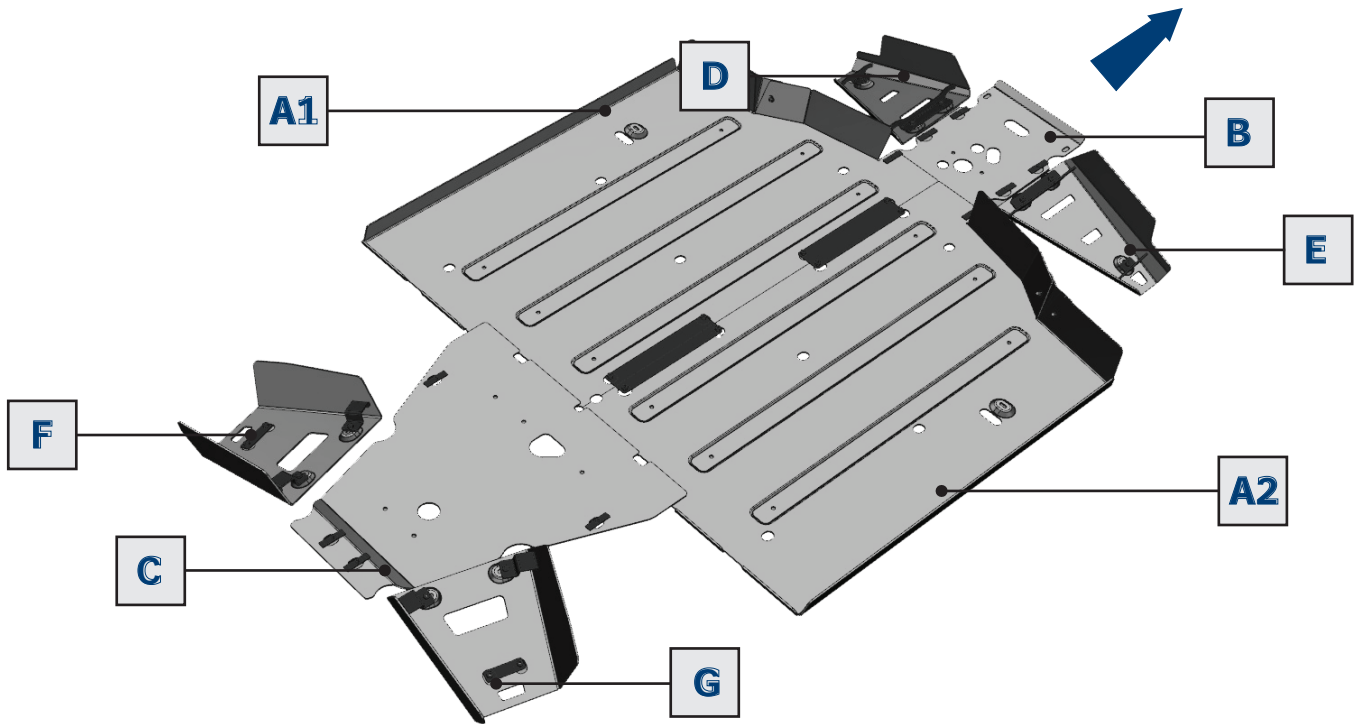

S - 10;
S - 13

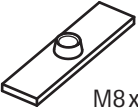
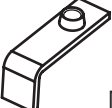
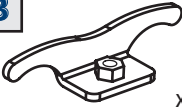
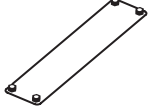
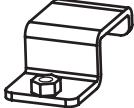
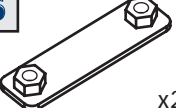
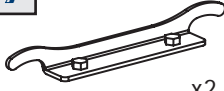

M6



1	 M8x10	2	 M8x2	3	 x2	4	 x2	5	 x4	6	 x2
7	 x2	8	 M6x25 x12	9	 M8x25 x34	10	 Ø8 x12	11	 Ø6 x12	12	 Ø8 x22

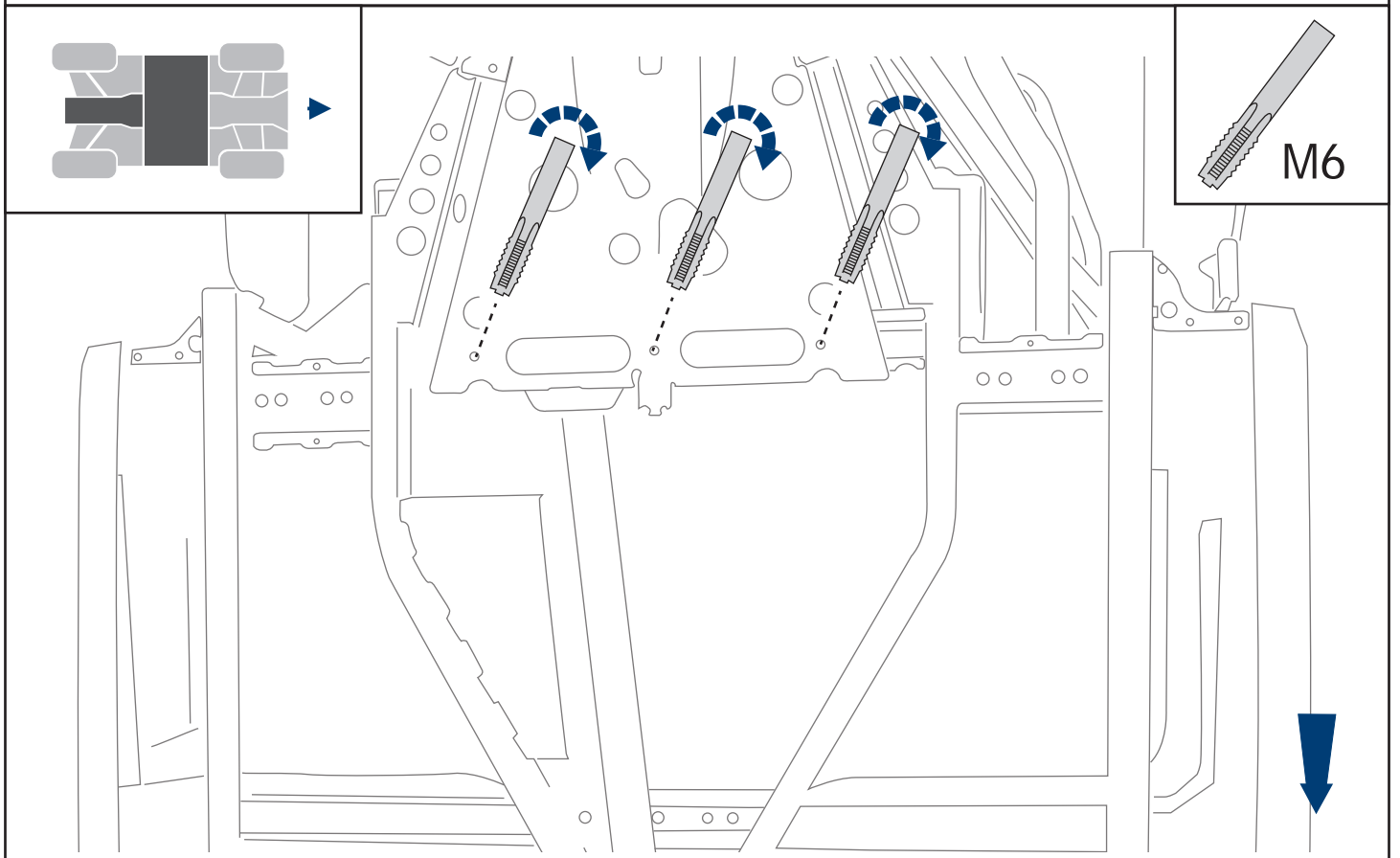
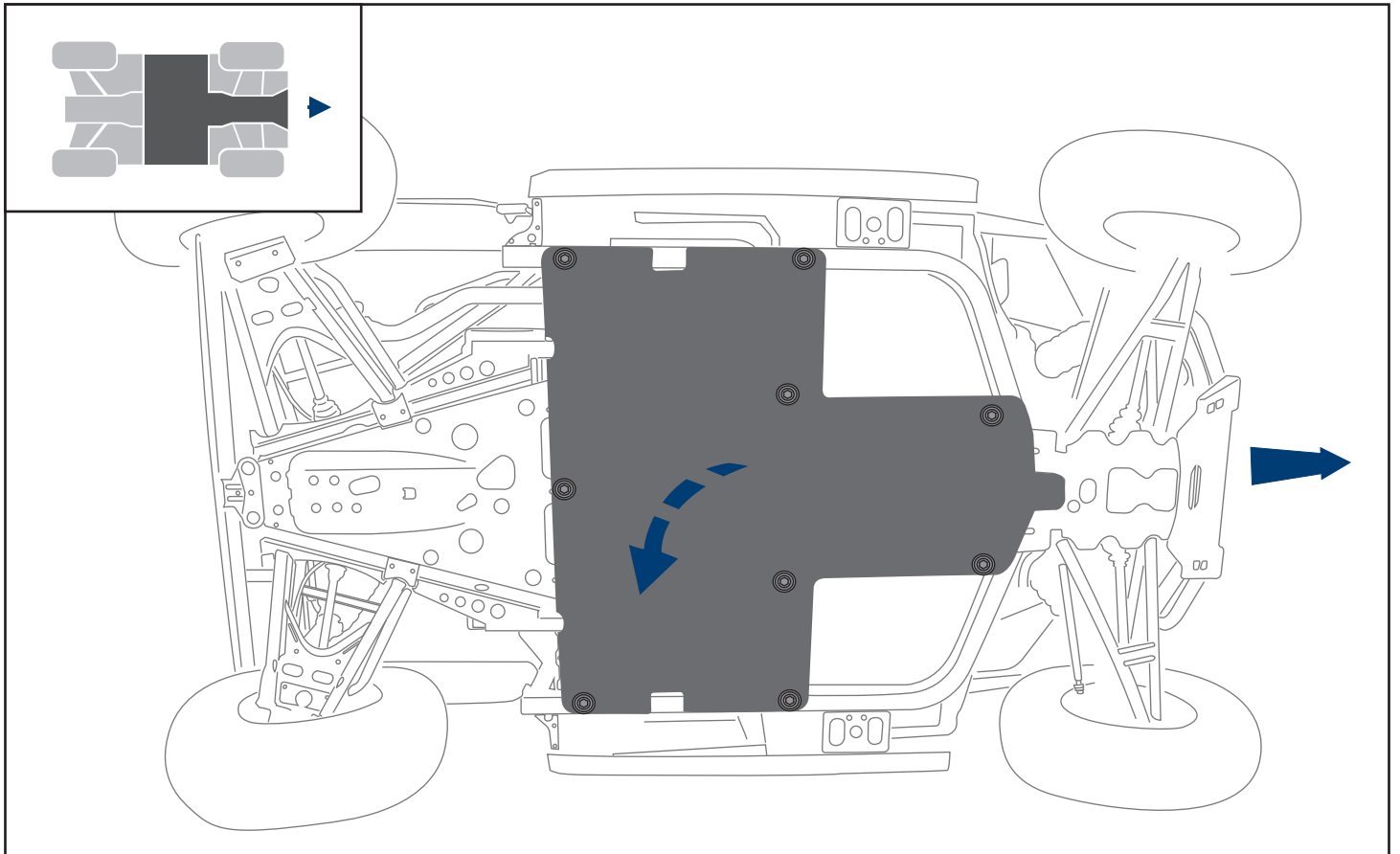

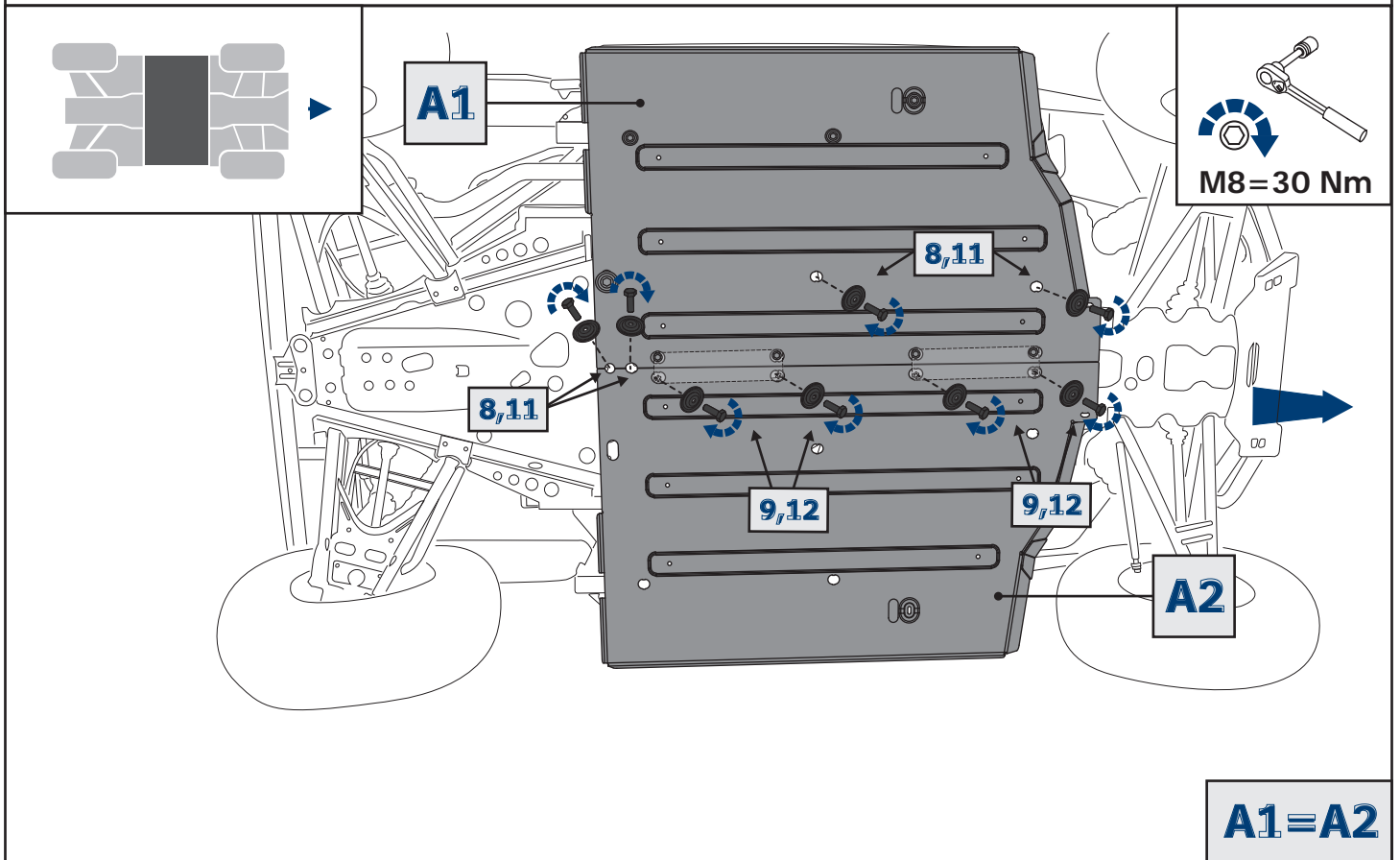
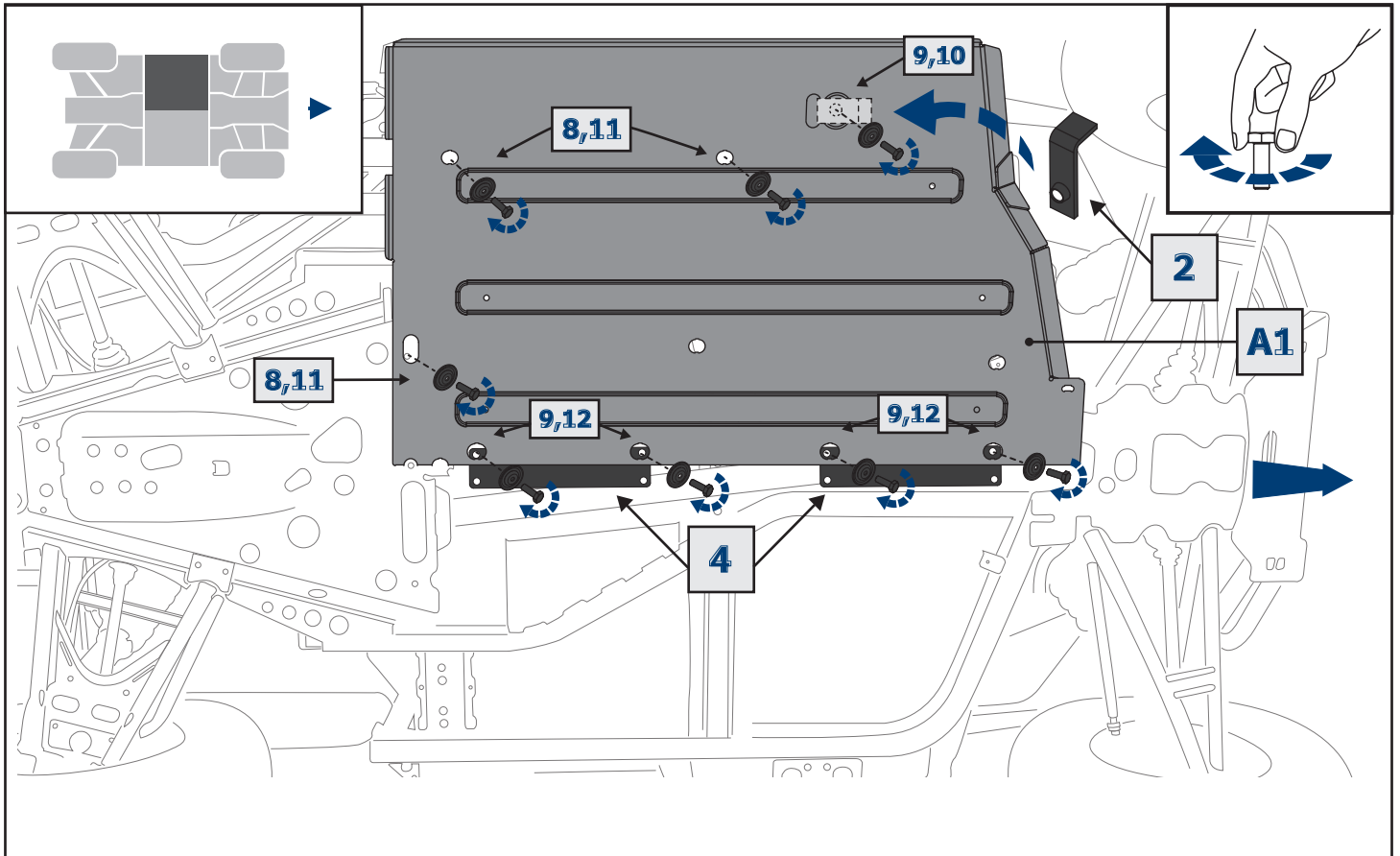

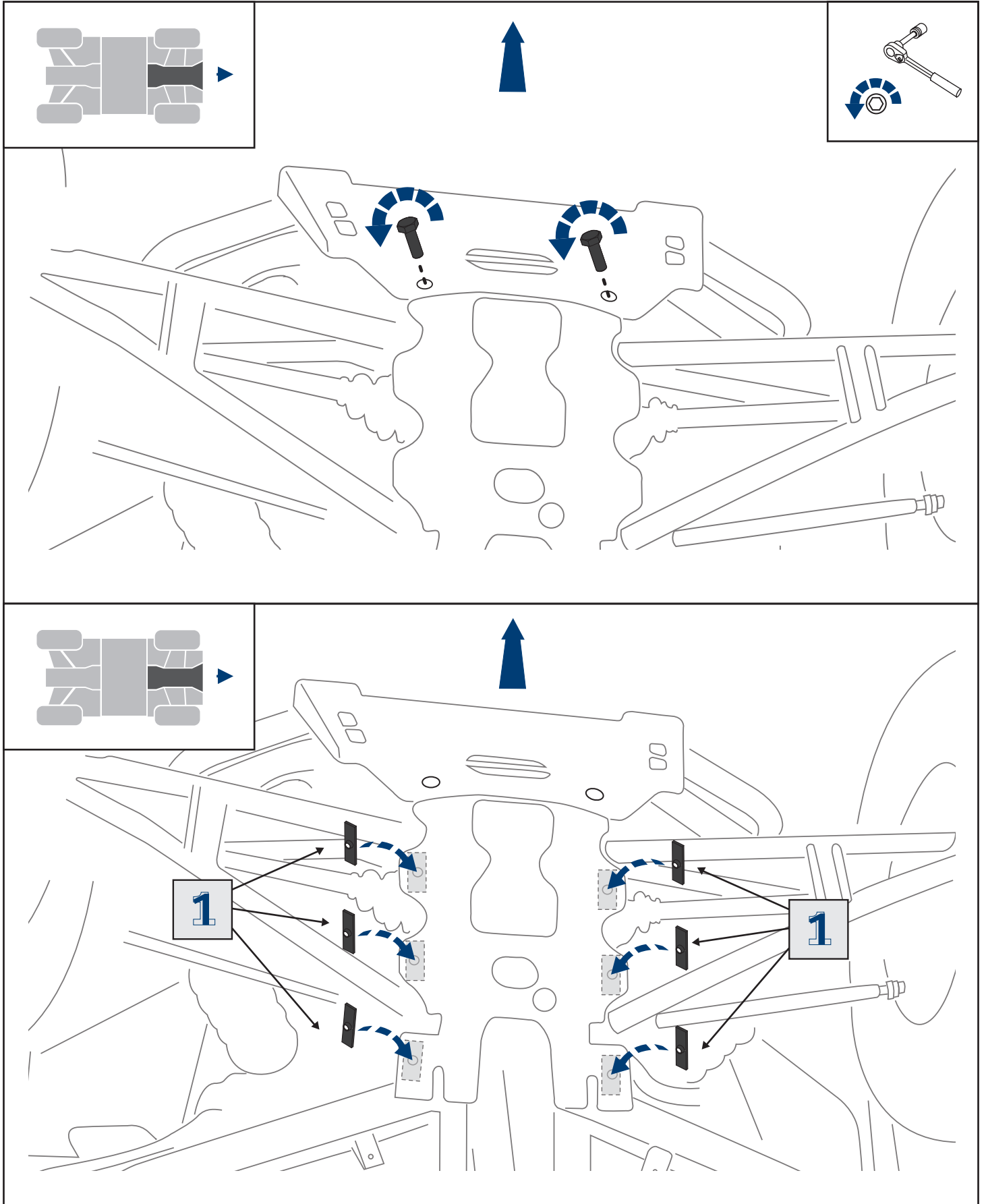

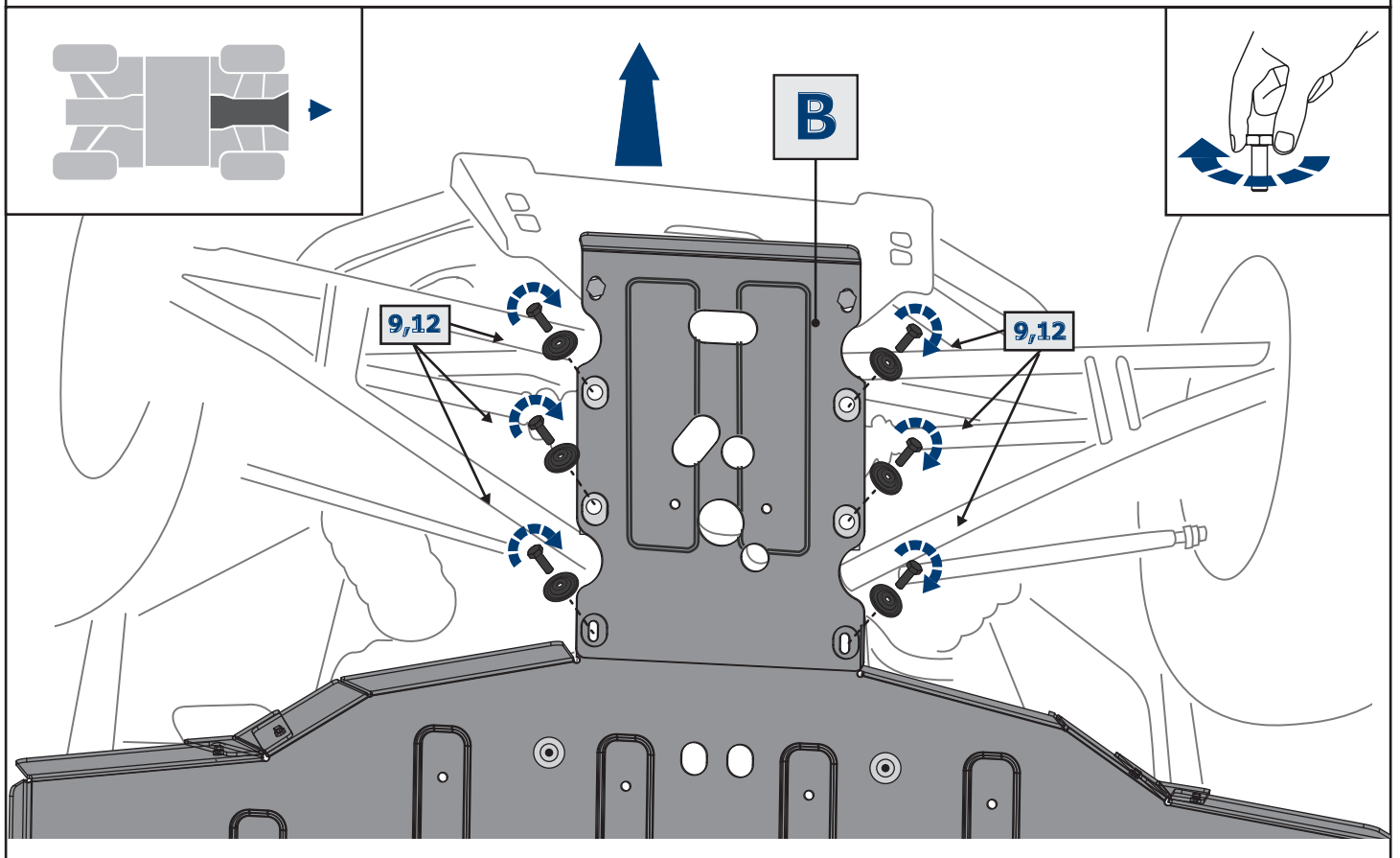
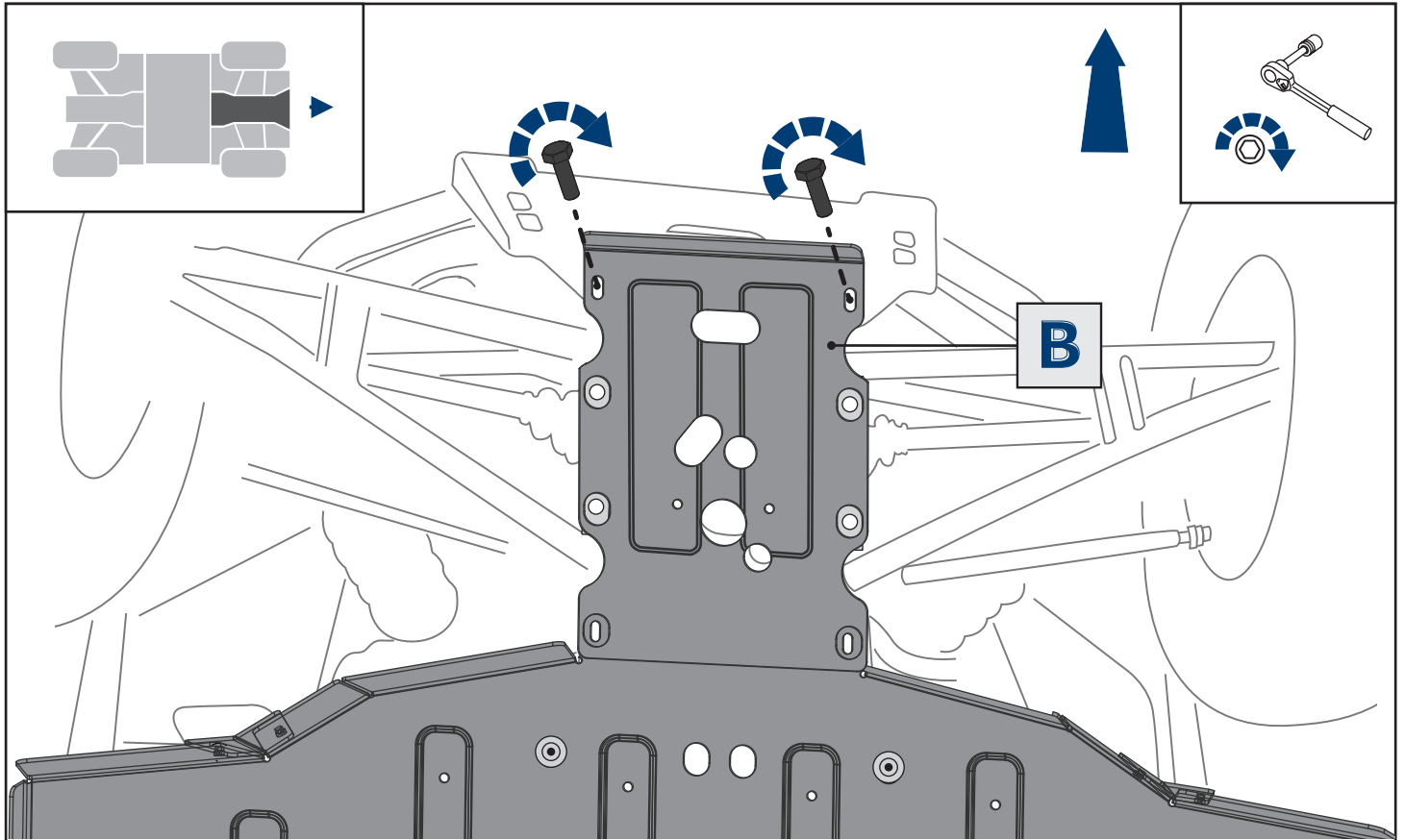

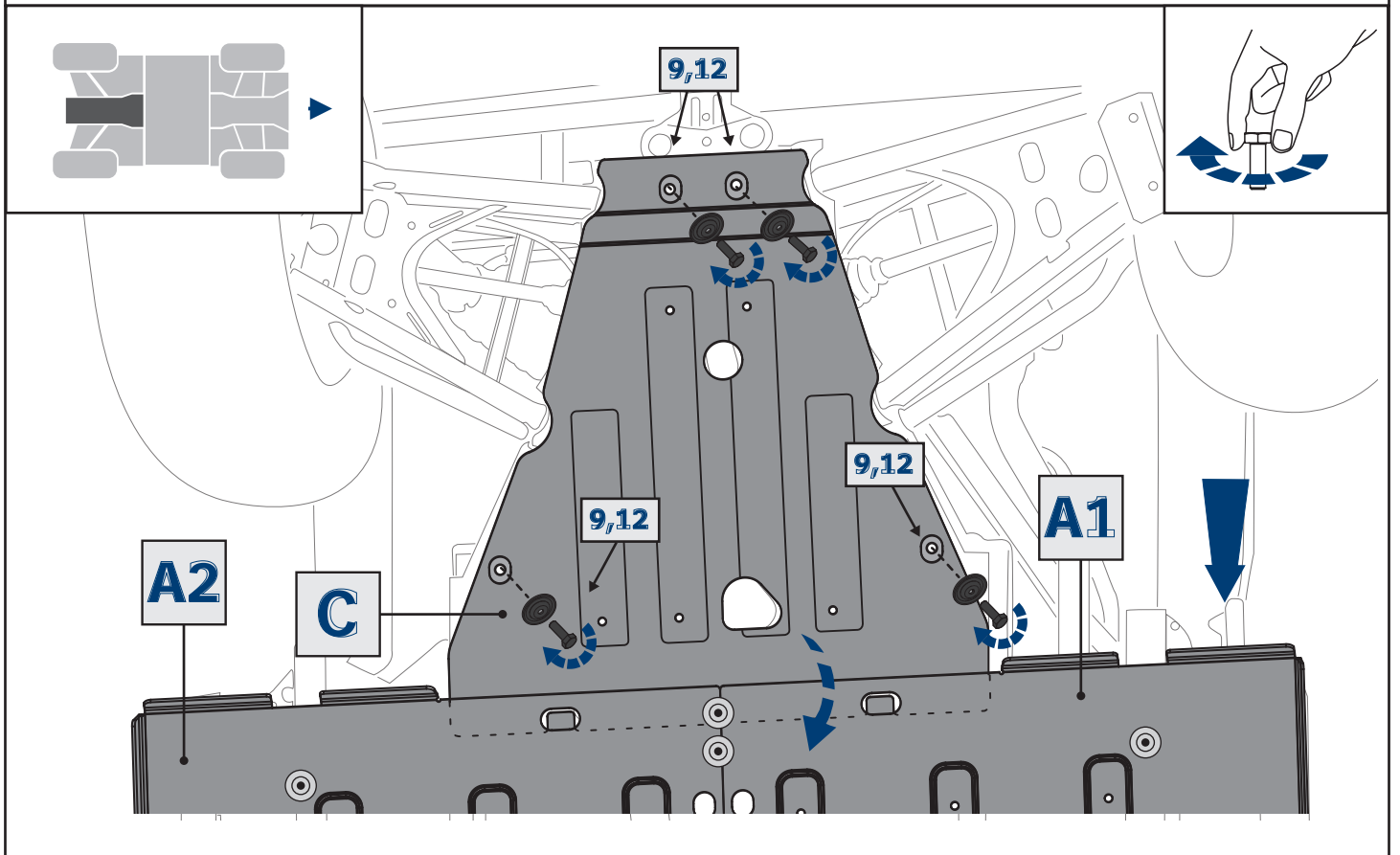
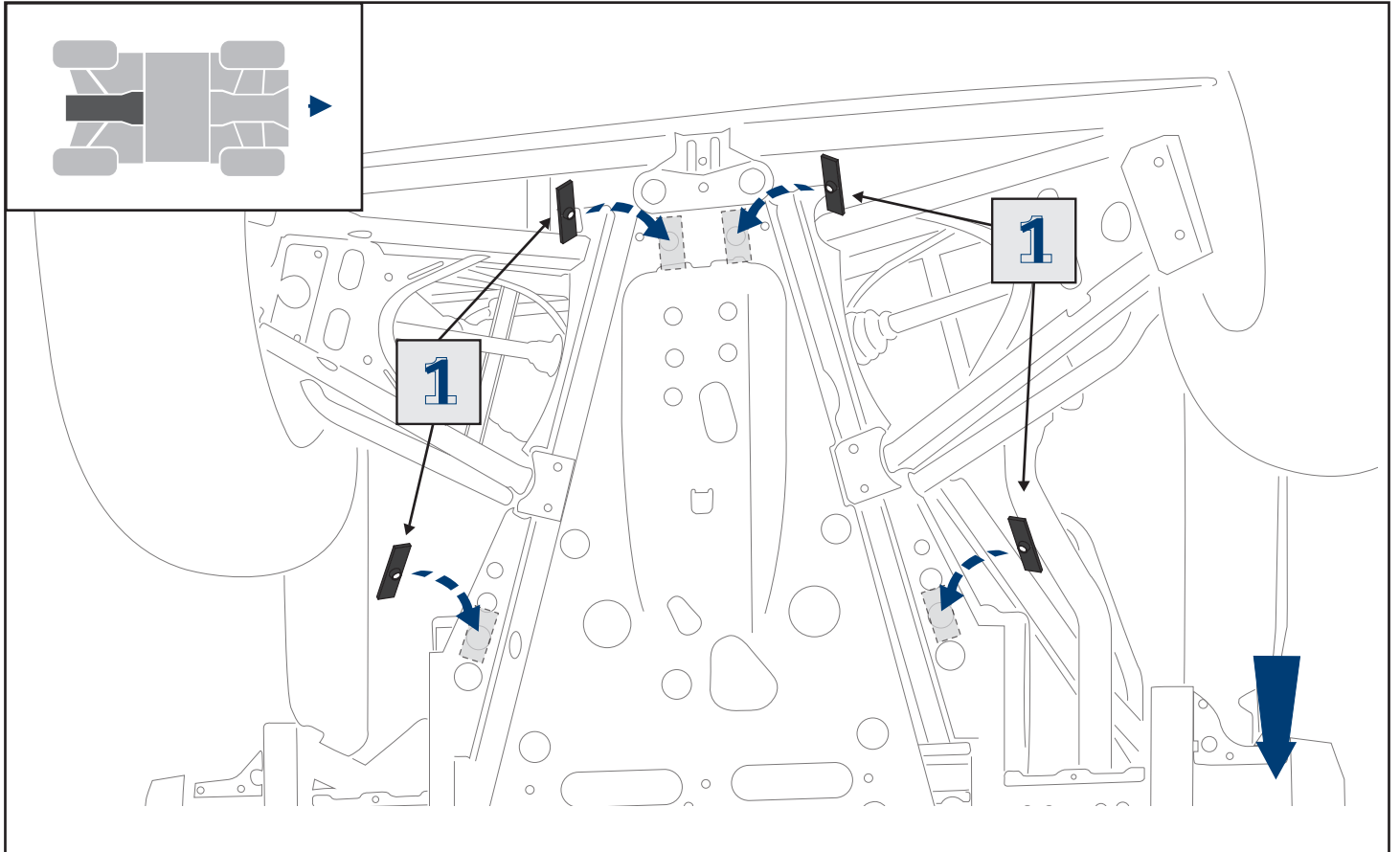

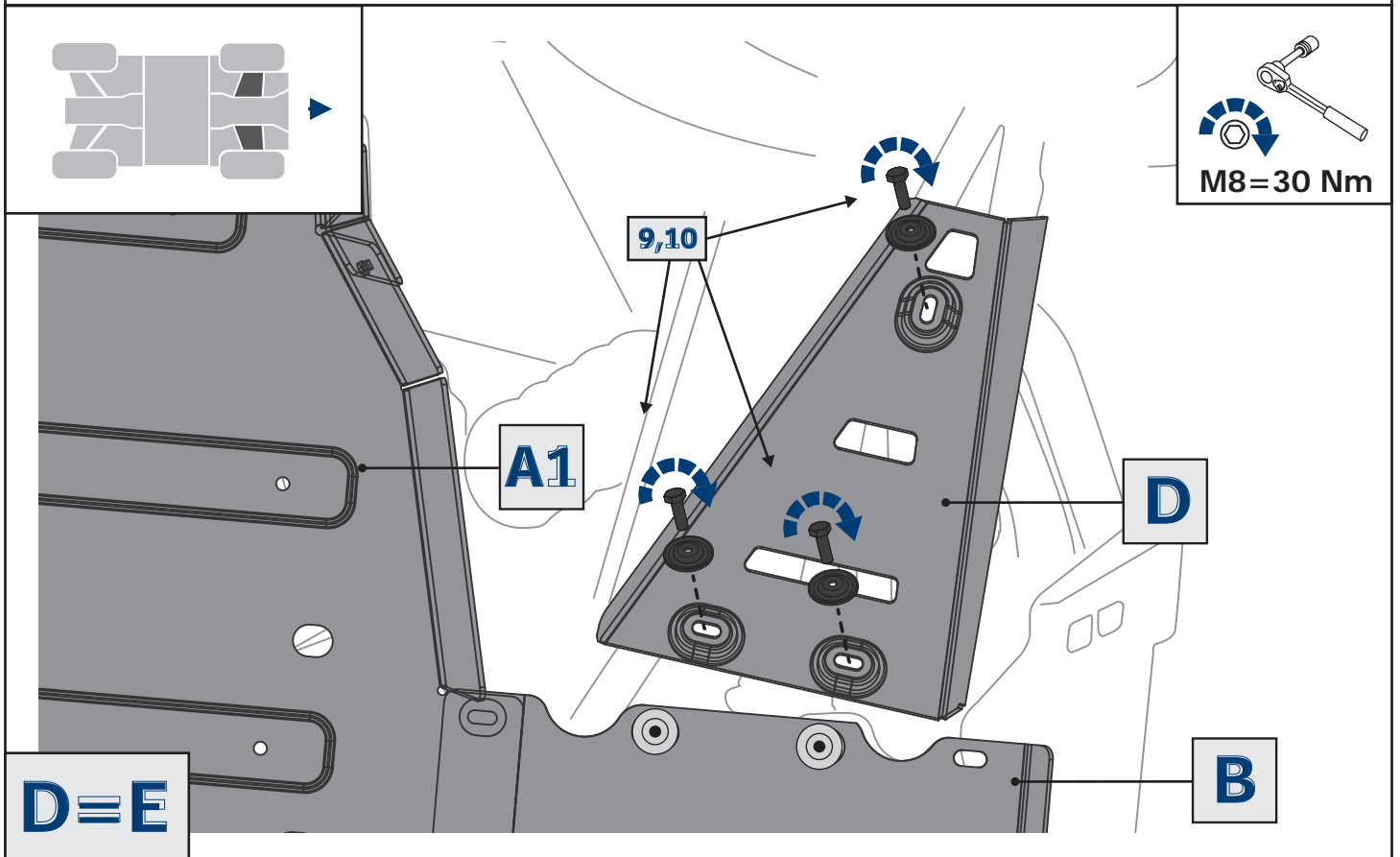
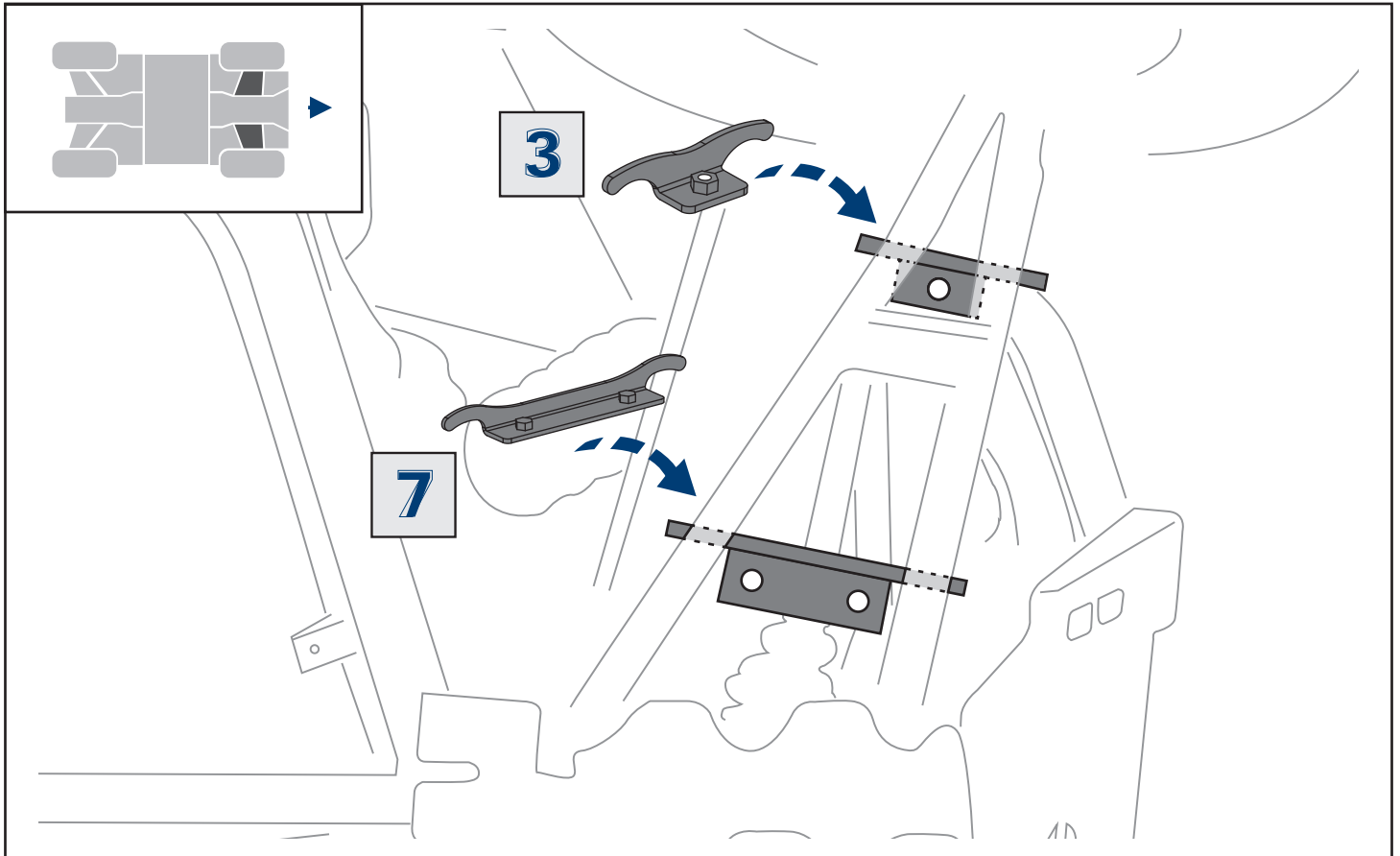

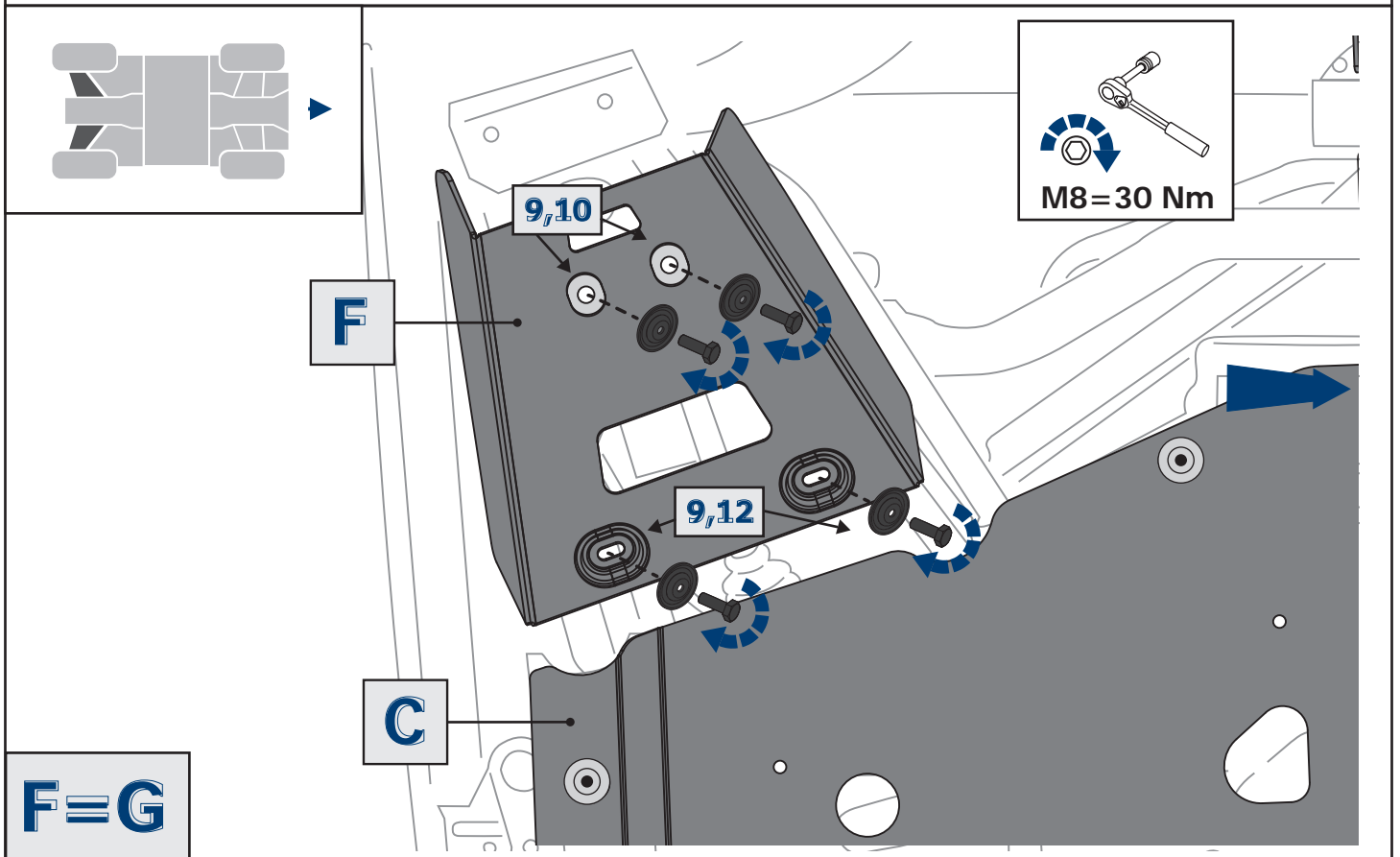
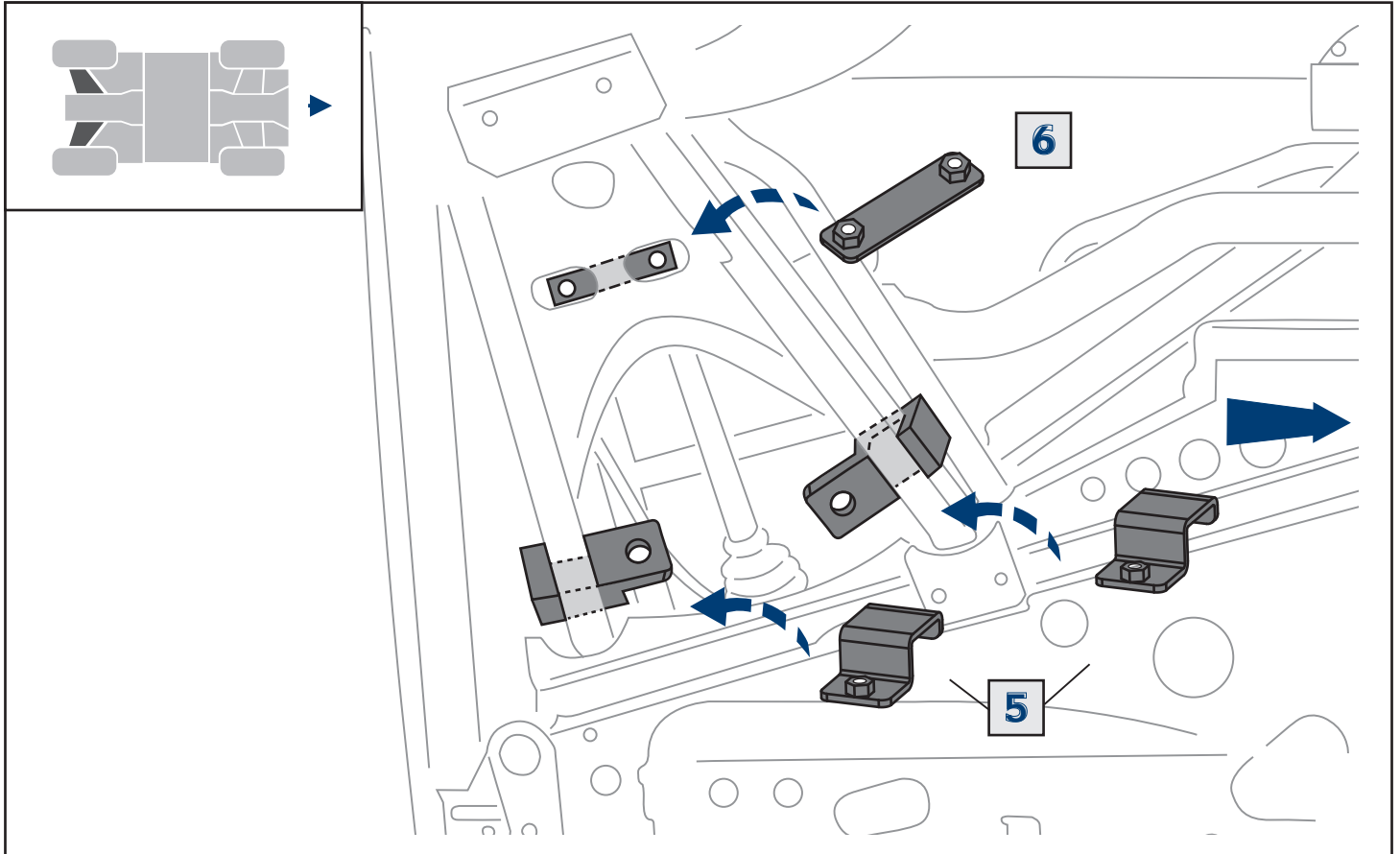

F=G

