

| | |
|----|---|
| EN | SKID PLATE INSTALLATION MANUAL |
| FR | MANUEL D'INSTALLATION DE PLAQUE DE PROTECTION |
| DE | MONTAGEEINLEITUNG FÜR UNTERBODENSCHUTZSYSTEM |
| RU | ИНСТРУКЦИЯ ПО УСТАНОВКЕ КОМПЛЕКТА ЗАЩИТ |



For: Yamaha Grizzly 700 (2016-)

2444.7124.1

444.7124.1



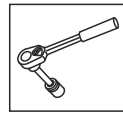



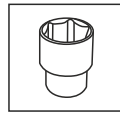



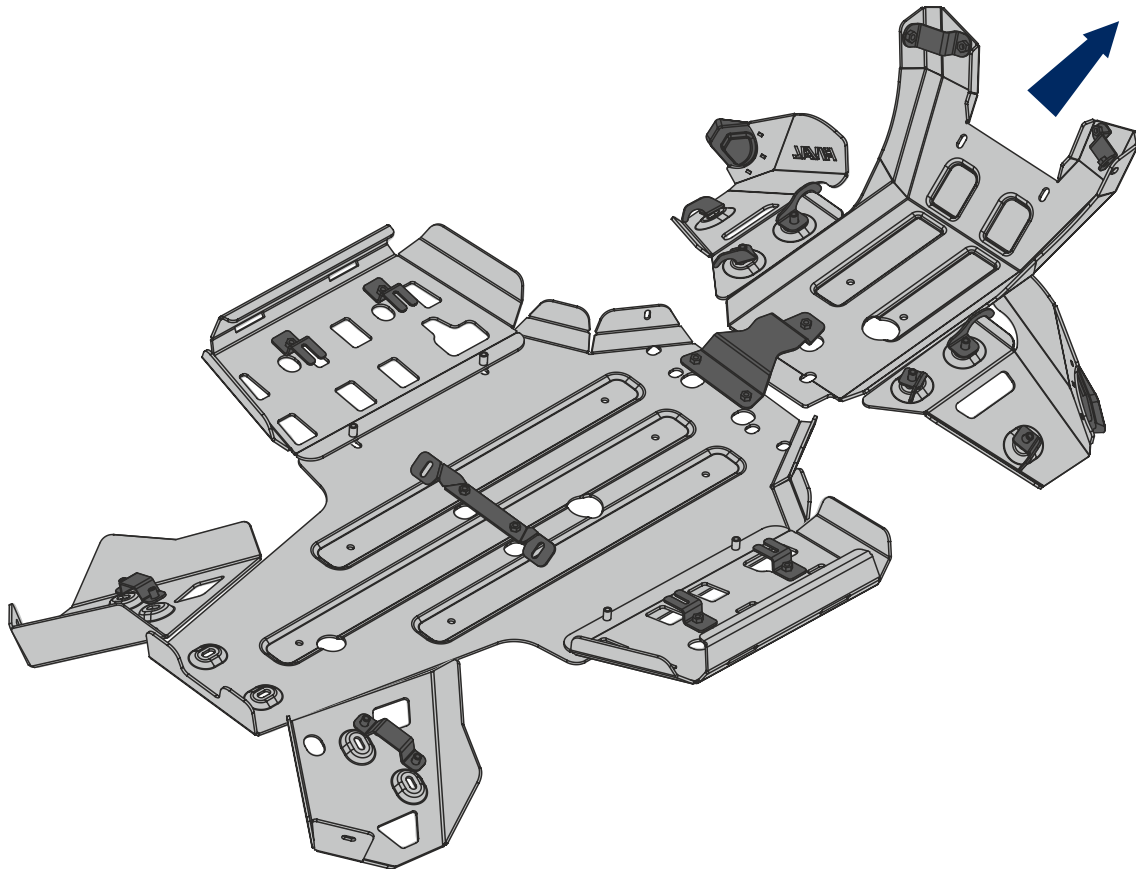

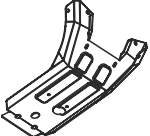
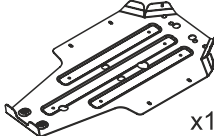
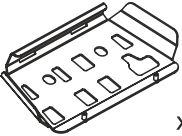
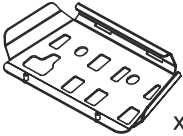
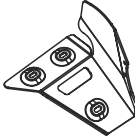



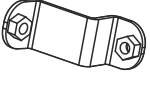
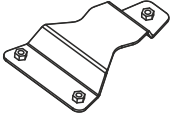
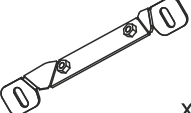
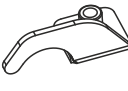

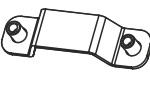
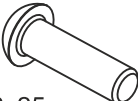
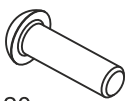
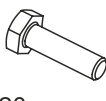
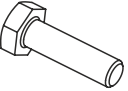
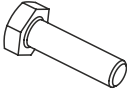
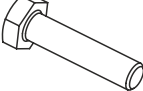
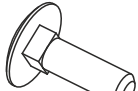



EN Ratchet
FR Clé À Cliquet
DE Ratsche
RU Трещетка





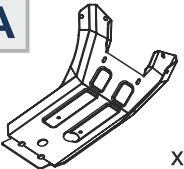
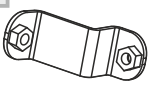
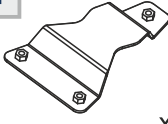

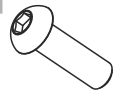
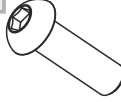
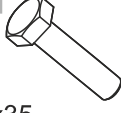

S - 10;
S - 13

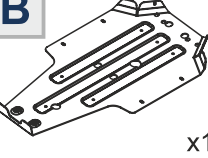
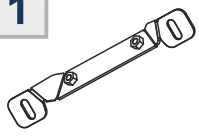

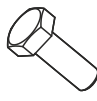
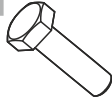

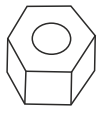

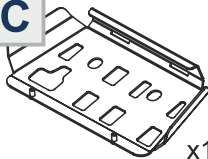
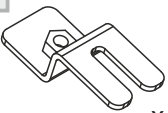

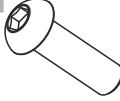
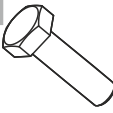
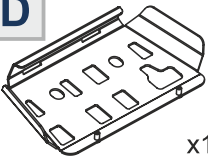

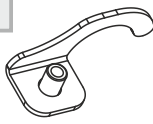

| | | | | | |
|---|--|--|--|--|--|
|  x1 |  x1 |  x1 |  x1 |  x1 |  x1 |
|  x1 |  x1 |  x2 |  x1 |  x1 |  x4 |
|  x4 |  x2 |  x2 |  M8x25 x8 |  M6x20 x2 |  M6x20 x8 |
|  M8x25 x16 |  M8x35 x3 |  M8x50 x2 |  M6 x6 |  Ø 8 x11 |  Ø 6 x6 |
|  Ø 6 x18 |  Ø 8 x20 |  M6 x8 |  M8 x2 |  x1 |  x1 |

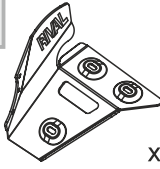
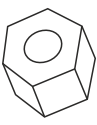
| | | | | | |
|---|--|--|---|---|---|
| A  x1 | 1  x2 | 2  x1 | 3  x1 | 4  x2 | 5  x4 |
| | 6  M6x20 x2 | 7  M8x25 x4 | 8  M8x35 x1 | | |

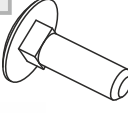
| | | | | | |
|--|---|--|--|--|---|
| B  x1 | 1  x1 | 2  M6x20 x6 | 3  M8x25 x2 | 4  M8x35 x2 | 5  x8 |
| | 6  x4 | 7  M6 x2 | | | |

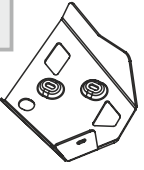
| | | | | | |
|---|---|---|---|--|---|
| C  x1 | 1  x4 | 2  x4 | 3  x4 | 4  M8x25 x4 | 5  M8x25 x4 |
| | D  x1 | | | | |

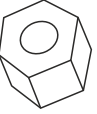
| | | | | | |
|---|---|---|--|---|---|
| E  x1 | 1  x1 | 2  x1 | 3  x2 | 4  x4 | 5  x6 |
| | F  x1 | 6  M6 x6 | 7  x6 | 8  x6 | 9  x6 |

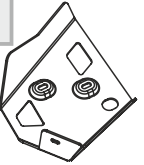
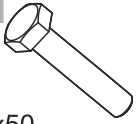
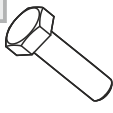
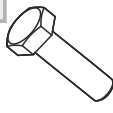
| | | | | | |
|---|---|--|--|--|---|
| G  x1 | 1  x2 | 2  x2 | 3  M8 x2 | 4  x6 | 5  x2 |
| | H  x1 | 6  M8x50 x2 | 7  M8x25 x4 | 8  M6x20 x2 | |

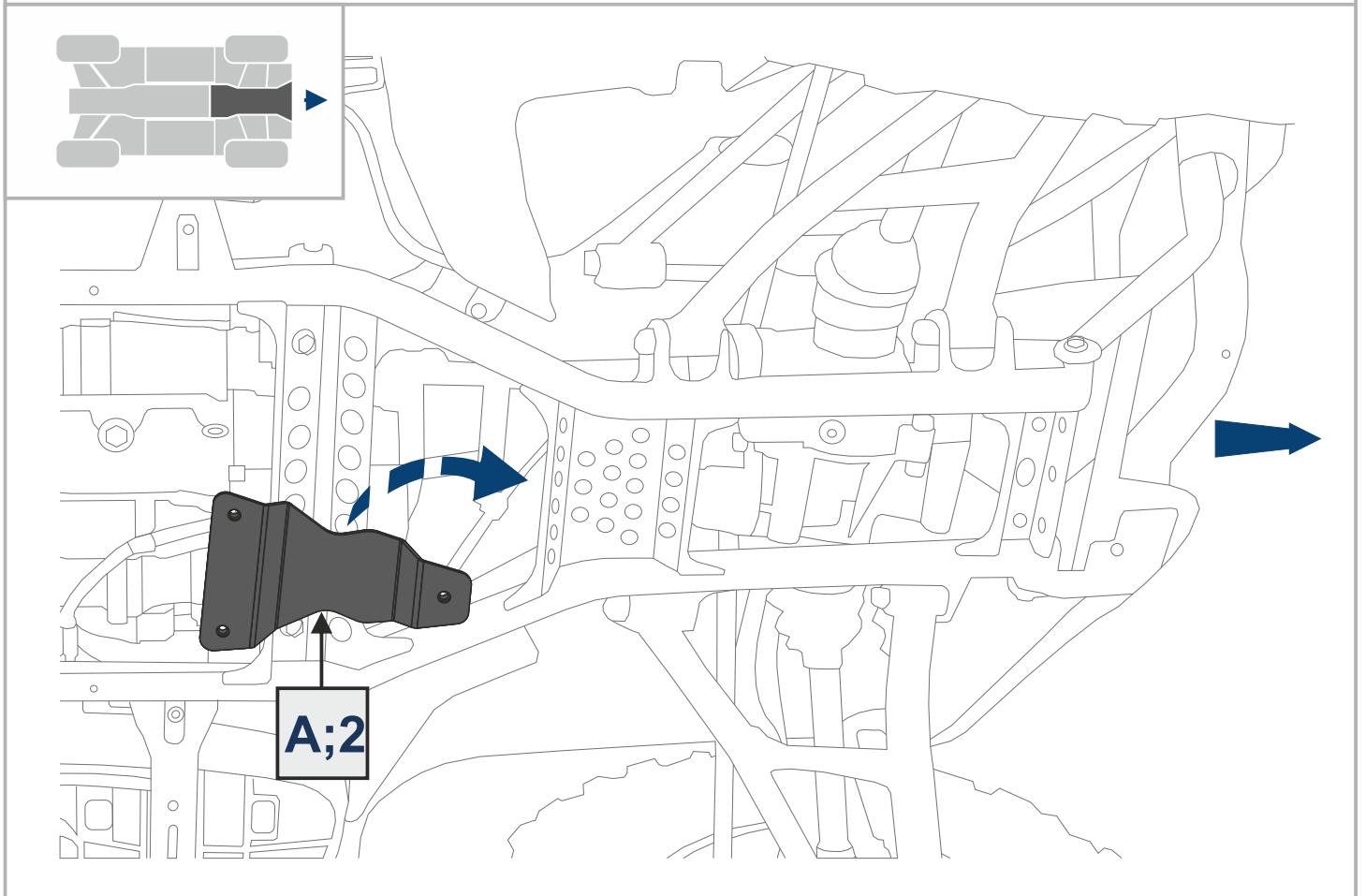
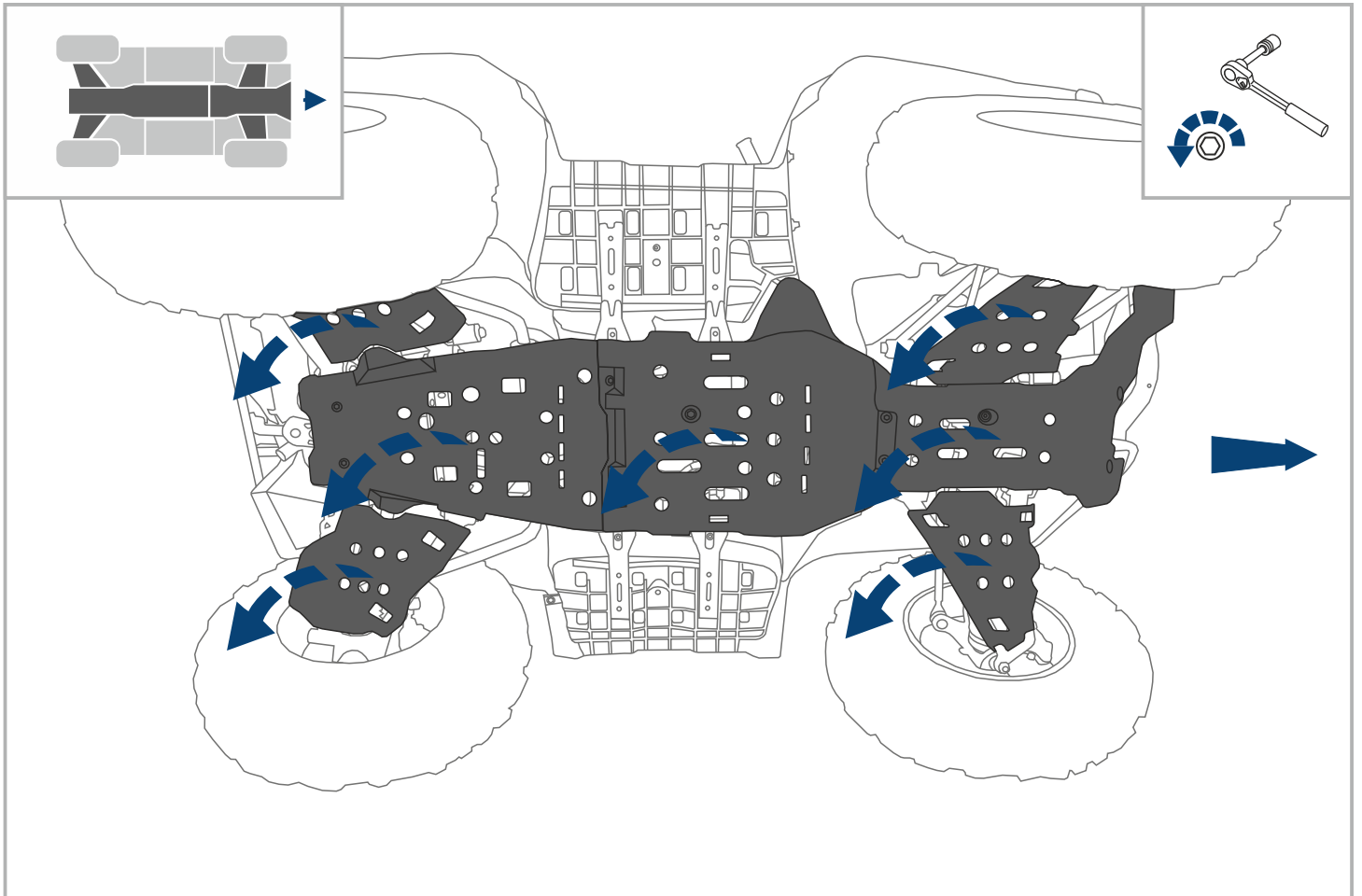

A;2

