

EN **BUMPER KIT INSTALLATION MANUAL**

DE **MONTAGEEINLEITUNG FÜR STOBFÄNGER-KIT**

RU **ИНСТРУКЦИЯ ПО УСТАНОВКЕ ЗАДНЕГО БАМПЕРА**



**For: CFORCE 800 XC/ 850/ 1000 (2018-2019)**  
**X8 H.O. EPS / X10 EPS (2018-2019)**

2444.6857.1



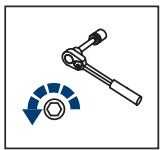

EN Regular fasteners  
DE Originale montageteile  
RU Штатный крепеж

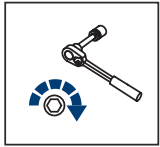

EN Regular fasteners  
DE Originale montageteile  
RU Штатный крепеж

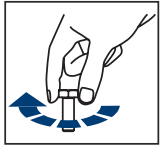

EN Screw a several turns  
DE Für wenigen Umdrehungen befestigen  
RU Вкрутить на несколько оборотов

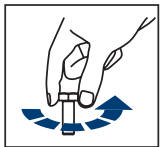

EN Loosen bolts  
DE Bolzen lockern  
RU Выкрутить на несколько оборотов

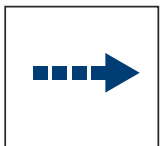

EN Movement Arrow  
DE Bewegungsrichtung  
RU Движение

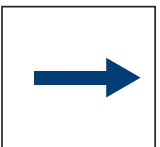

EN Location/Position Arrow  
DE Anordnung/Positionsrichtung  
RU Расположение



EN Screw Arrow  
DE Drehungsrichtung  
RU Поворот

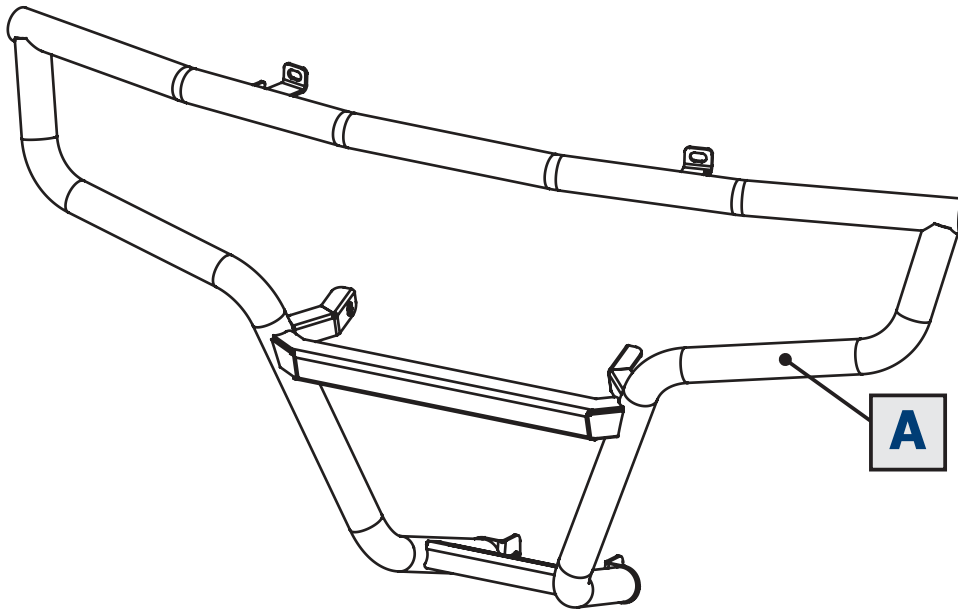

EN Office Knife  
DE Büromesser  
RU Канцелярский нож

**1**

M8x20

x4

**2**

Ø8

x4

