

















Вынос радиатора SMC Jumbo

Material: steel

Основные комплектующие изделия № 40.MP 0156 V

№	Кол-во	Наименование	Вид	№	Кол-во	Наименование	Вид
1	4	Уголок		16	17	Гайка М6	
2	2	Хомут		17	1	Сетка	
3	2	Фланец		18	4	Гайка М10	
4	1	Фланец		19	20	Шайба 4	
5	2	Крюк		20	9	Шайба 6Г	
6	6	Болт М8х20		21	4	Шайба 8Г	
7	22	Винт М6х16		22	8	Шайба 10	
8	4	Винт М6х20		23	23	Шайба 6	
9	1	Винт М6х30		24	6	Шайба 8	
10	1	Кронштейн		25	9	Шайба 6	
11	1	Кронштейн		26	4	Шайба 8	
12	1	Кронштейн		27	4	Винт М8х20	
13	1	Перемычка		28	4	Винт М10х25	
14	1	Втулка		29	1	Кронштейн	
15	2	Боковина					

MP 0156 V

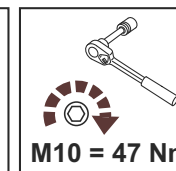
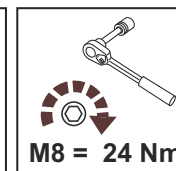
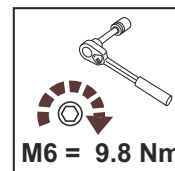

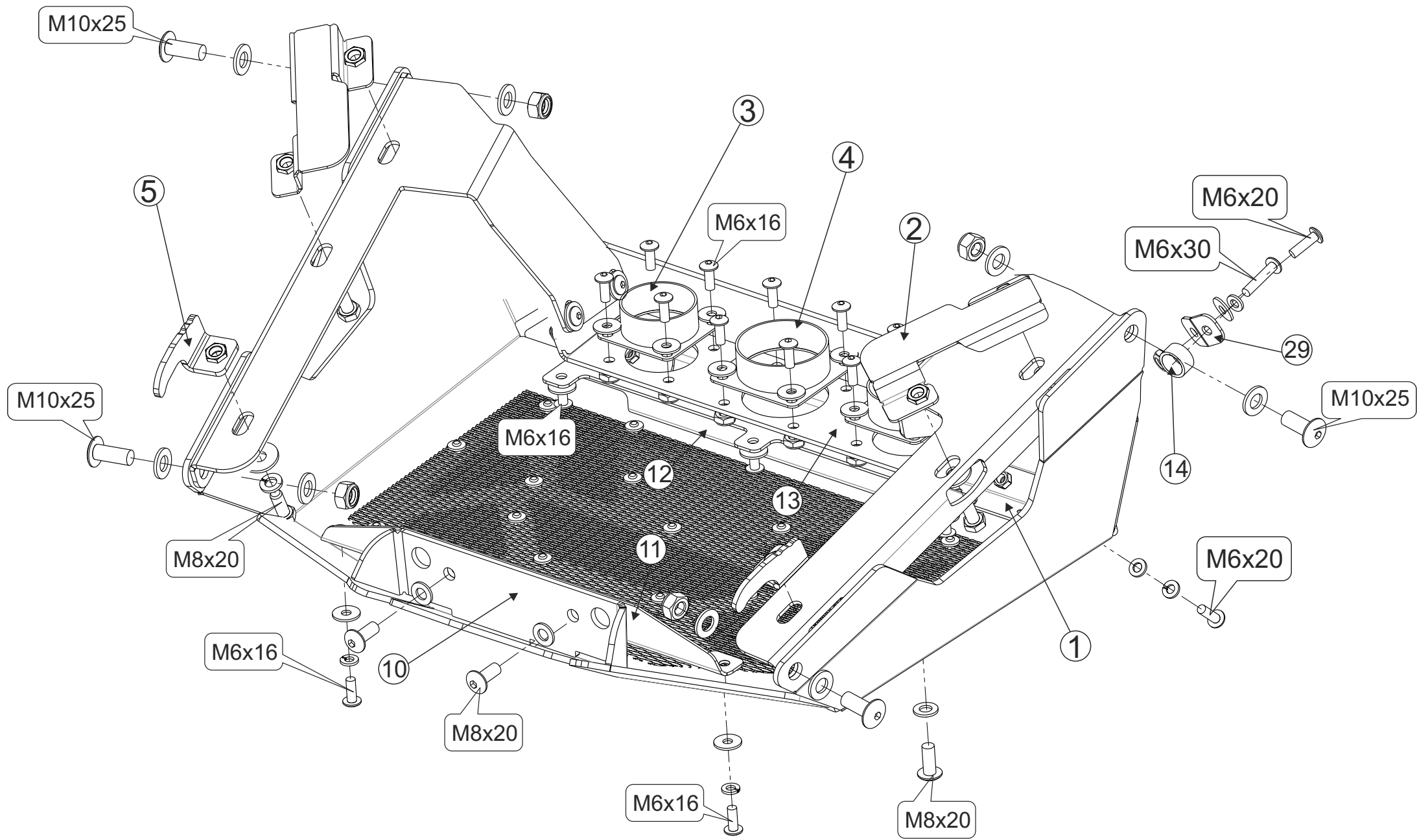

www.stormprotect.ru