

EN	SKID PLATE INSTALLATION MANUAL
FR	MANUEL D'INSTALLATION DE PLAQUE DE PROTECTION
DE	MONTAGEEINLEITUNG FÜR UNTERBODENSCHUTZSYSTEM
RU	ИНСТРУКЦИЯ ПО УСТАНОВКЕ КОМПЛЕКТА ЗАЩИТ



For: CF MOTO 500 H.O. (2015-)

2444.6846.1

444.6846.1



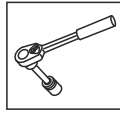



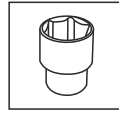



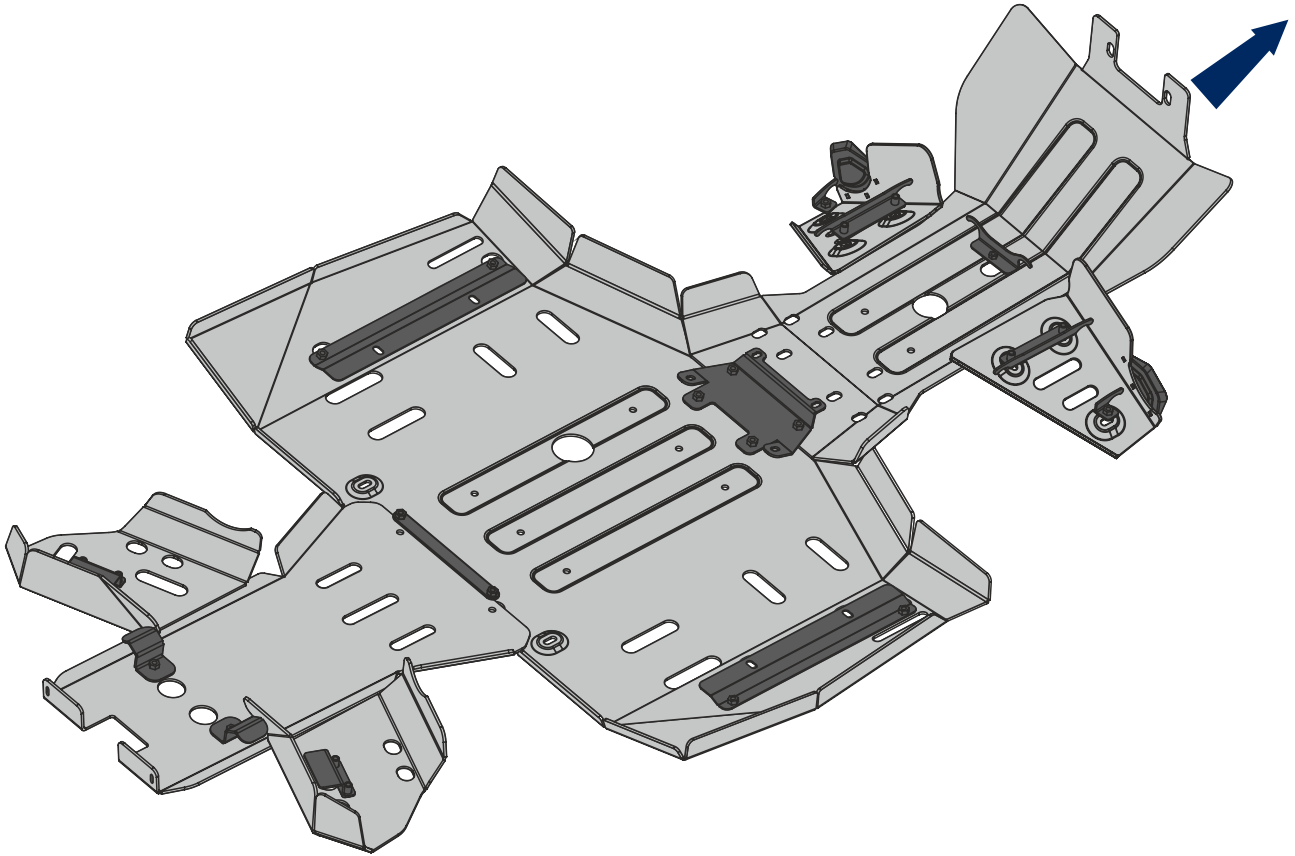

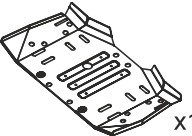
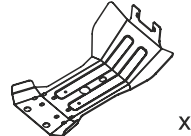
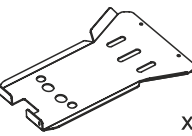
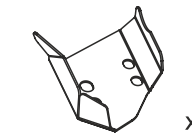
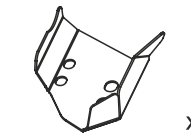
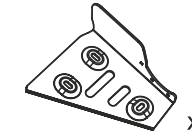
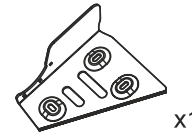
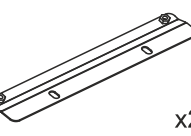
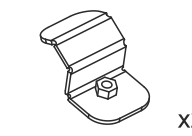
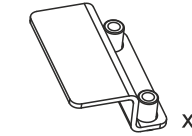
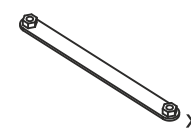
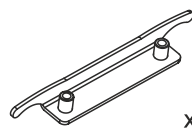
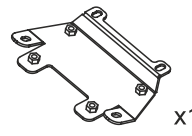
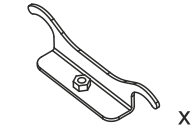
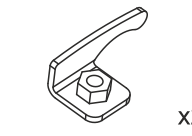
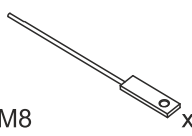
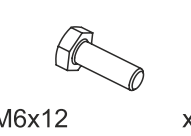
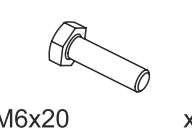
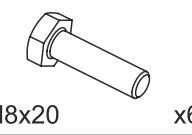
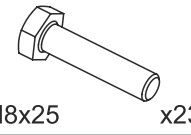
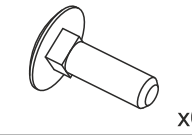



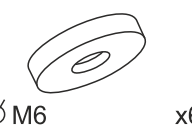
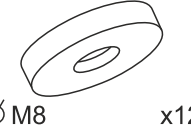

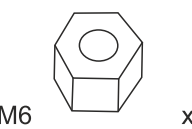

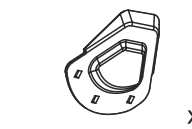

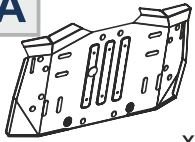
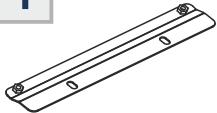
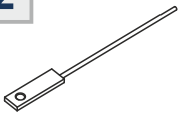

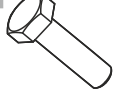

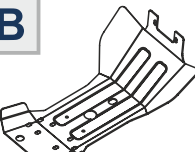
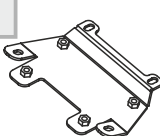
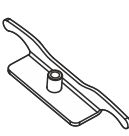

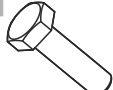
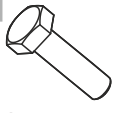
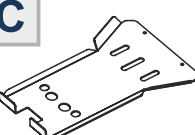
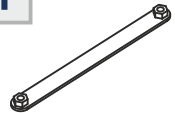
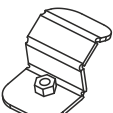

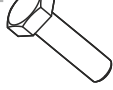
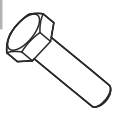

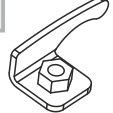
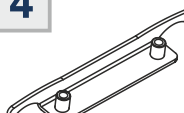

EN Ratchet
FR Clé À Cliquet
DE Ratsche
RU Трещетка

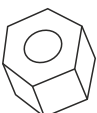
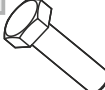
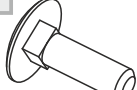

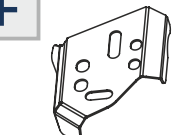
S - 10;
S - 13

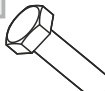

 x1	 x1	 x1	 x1	 x1	 x1
 x1	 x2	 x2	 x2	 x1	 x2
 x1	 x1	 x2	 M8 x4	 M6x12 x4	 M6x20 x6
 M8x20 x6	 M8x25 x23	 x6	 Ø M6 x4	 Ø M8 x17	 Ø M6 x6
 Ø M6 x6	 Ø M8 x12	 Ø M6 x6	 M6 x6	 x1	 x1

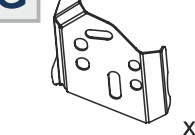
<p>A</p>  <p>x1</p>	<p>1</p>  <p>x2</p>	<p>2</p>  <p>M8 x4</p>	<p>3</p>  <p>∅8 x6</p>	<p>4</p>  <p>M8x20 x6</p>	<p>5</p>  <p>M8x25 x6</p>
	<p>6</p>  <p>∅8 x6</p>				
<p>B</p>  <p>x1</p>	<p>1</p>  <p>x1</p>	<p>2</p>  <p>x1</p>	<p>3</p>  <p>∅8 x3</p>	<p>4</p>  <p>∅6 x4</p>	<p>5</p>  <p>M6x20 x4</p>
	<p>6</p>  <p>M8x25 x3</p>				
<p>C</p>  <p>x1</p>	<p>1</p>  <p>x1</p>	<p>2</p>  <p>x2</p>	<p>3</p>  <p>∅8 x3</p>	<p>4</p>  <p>∅6 x2</p>	<p>5</p>  <p>M6x20 x2</p>
	<p>6</p>  <p>M8x25 x3</p>				
<p>D</p>  <p>x1</p>	<p>1</p>  <p>x1</p>	<p>2</p>  <p>x1</p>	<p>3</p>  <p>x2</p>	<p>4</p>  <p>x2</p>	<p>5</p>  <p>∅6 x6</p>
<p>E</p>  <p>x1</p>	<p>6</p>  <p>M6 x6</p>	<p>7</p>  <p>M8x25 x6</p>	<p>8</p>  <p>x6</p>	<p>9</p>  <p>∅6 x6</p>	<p>10</p>  <p>∅8 x6</p>
<p>F</p>  <p>x1</p>	<p>1</p>  <p>x2</p>	<p>2</p>  <p>M8x25 x4</p>	<p>3</p>  <p>M6x12 x4</p>	<p>4</p>  <p>∅6 x4</p>	<p>5</p>  <p>∅8 x4</p>
<p>G</p>  <p>x1</p>					

